



Historic England

# Graphical and Plane Table Survey of Archaeological Earthworks

Good Practice Guidance



# Summary

This guidance is for anyone interested in deploying ‘traditional’ non-electronic methods of survey to record and interpret the archaeology of an earthwork site. The use of simple methods of measurement described in this guidance using tapes, a plane table or an optical square will help both experienced landscape archaeologists and novice practitioners to develop their observational and analytical skills. The guidance covers the range of techniques that can be deployed while embedded links to specially commissioned video clips reinforce understanding by showing many of the techniques being used in the field. The guidance also considers the integration of manual survey techniques with a Total Station Theodolite (TST) or a Global Navigation Satellite System (GNSS).

This revised version of the 2002 edition is one of several pieces of Historic England guidance available from the Historic England website, including:

*[Understanding the Archaeology of Landscapes](#)*

*[Traversing the Past: The Total Station Theodolite in Archaeological Landscape Survey](#)*

*[Understanding Historic Buildings: a Guide to Good Recording Practice](#)*

*[Where on Earth Are We? The Role of Global Navigation Satellite Systems \(GNSS\) in Archaeological Field Survey](#)*

This guidance has been prepared by Trevor Pearson. It builds on the 2002 edition written by Mark Bowden. First published by English Heritage March 2002. This edition published by Historic England October 2018. All images © Historic England unless otherwise stated.

Please refer to this document as Historic England 2018 *Graphical and Plane Table Survey of Archaeological Earthworks*. Second Edition. Swindon. Historic England.

[HistoricEngland.org.uk/advice/technical-advice/recording-heritage/](https://HistoricEngland.org.uk/advice/technical-advice/recording-heritage/)

---

**Front cover:**

Using a plane table at Snodhill Castle, Herefordshire

# Contents

<b>Introduction.....</b>	<b>2</b>	<b>5</b>	<b>The Pros and Cons .....</b>	<b>23</b>
<b>1 The Value of These Techniques ....</b>	<b>3</b>	<b>6</b>	<b>Ancillary Techniques .....</b>	<b>24</b>
<b>2 Reconnaissance and Control .....</b>	<b>5</b>	6.1	Prismatic compass.....	24
<b>3 Graphical Survey in the Field .....</b>	<b>6</b>	6.2	Pocket level.....	24
3.1 Equipment.....	6	<b>7</b>	<b>Products.....</b>	<b>26</b>
3.2 Survey Methodology.....	7	7.1	Field, archive and publication plans .....	26
3.3 The control network .....	7	7.2	Field notes, archive and publication reports.....	27
3.4 Detailed Recording .....	9	<b>8</b>	<b>Conclusion .....</b>	<b>28</b>
<b>4 Plane Table Survey .....</b>	<b>16</b>	<b>9</b>	<b>Glossary .....</b>	<b>29</b>
4.1 Equipment.....	16	<b>10</b>	<b>Where to Get Advice .....</b>	<b>30</b>
4.2 Method.....	17		Contact Historic England .....	32



# Introduction

Earthwork survey is one of the oldest archaeological techniques, with an unbroken tradition in this country dating back to the work of 17th and 18th century fieldworkers such as John Aubrey, William Stukeley and William Roy. Archaeological earthwork survey is now widely recognised as a powerful analytical tool capable of revealing the development of a site through the detailed observation and mapping of visible surface remains. The purpose of archaeological earthwork survey is therefore twofold. First, it is intended to produce an accurate scale plan of the site – to record it. Secondly, and at least as important, is to gain understanding of the site – to interpret it.

Up until the 1970s the techniques and equipment used to record archaeological earthwork sites were basically the same as those deployed in the 18th century. However during the last four decades the introduction of electronic survey equipment such as total station theodolites (TST), Global navigation satellite systems (GNSS), digital data recording and computer generated mapping have revolutionised the speed at which survey can be undertaken and introduced different ways of depicting earthwork sites using, for example, closely-spaced contours and 3D surface models (DTM). Moreover, the facility to record sites accurately from the air using rectified aerial photographs, lidar and low-level photography using small unmanned aircraft offers further ways of recording earthworks.

The graphical and plane table techniques which are the subject of this guidance still have an important part to play in archaeological survey. Indeed it can be argued that because they involve direct hand-measurement of the ground surface they are the best way for the novice surveyor to develop their observational and analytical skills. No one should confuse the ability to use electronic instruments with the ability to see and understand archaeological remains; the second is not necessarily a corollary of the first.

---

## Opposite

Teaching tape and offset survey at Muncaster Castle, Cumbria.

# 1 The Value of These Techniques

Undertaking archaeological earthwork survey by graphical or plane table techniques is immensely rewarding. Seeing the plan grow and recognising patterns as they emerge (from even the most apparently unprepossessing set of humps and bumps) is a real thrill. Everyone makes mistakes, but with these techniques errors are quickly recognised and corrected.

There is a pleasing logic about the methodology, which, once grasped, is a source of satisfaction in its own right. Finally, spending time on a site using a plane table or tape measures, in close physical contact with the ground, gives a depth of knowledge and understanding that cannot be gained in any other way – all-but invisible features become apparent as the site is seen from different directions and in different light conditions, and the character of the earthworks becomes clear. Drawing the plan and writing the report to convey this understanding is an integral, and equally rewarding, part of the process, as will be discussed at the end of this document. The other benefits of traditional survey techniques include:

- **Cost** – the basic tools are cheap in comparison with electronic survey equipment such as a TST or survey grade GNSS receiver or the cost of acquiring surface data remotely from the air. Traditional survey techniques are unrivalled for enabling detailed and accurate earthwork survey on a tight budget.
- **Reliability** – there is no risk of power loss or component failure as with electronic survey equipment and local conditions have far less impact on reliability. A GNSS receiver is often unusable near buildings or trees and a TST may not record properly in heavy rain or mist.
- **Depiction** – hand-drawing a survey plan by direct measurement of the ground is often the best approach to depicting the subtle relationships between earthworks accurately. For this reason, even when electronic survey equipment is used for the majority of a survey, it is still advisable to measure the most complex areas of earthworks by hand, as will be discussed in more detail below.

- **Training** – hand measurement and hand drawing in the field teaches the principles of survey and the fundamentals of earthwork analysis, as it demonstrates the need for close observation, continuous assessment of the evidence and accurate measurement of detail. While the same can be taught using electronic survey equipment, learning how to operate the hardware and software often takes over and the more fundamental skills of observation, accurate measurement and interpretation are lost sight of.
- **Portability** – when working on small sites in remote areas it is often easier to use graphical survey techniques which involves carrying little more than a drawing board, three tape measures and a couple of ranging rods rather than to having to carry heavy and bulky electronic survey equipment from the nearest road.

It is also worth pointing out some of the limitations of graphical and plane table survey:

- **Speed** – this type of survey cannot compete with electronic techniques when it comes to speed of data collection and often in commercial survey projects this is of paramount importance.
- **Final product** – this is typically a scale plan drawn in pencil on polyester drawing film which will require scanning and digitising to give it some of the same flexibility as a digital survey captured electronically. A digital survey captured electronically in the field can be reproduced straight away at the scale of survey or smaller, edited to show phasing and processed to create 3D surface models and is therefore far more adaptable than a hand-drawn survey.

- **Fixing to the National Grid** – a hand-drawn survey requires careful manipulation to fix it in the correct position and orientation on the National Grid, as will be described in more detail below. In contrast a digital survey employing GNSS will be located on to the National Grid (often in real time) to a far greater degree of accuracy than can ever be achieved by manipulating a hand-drawn plan.

Conventional hachured survey has been found the best way to portray earthworks and their interrelationships (see [Understanding the Archaeology of Landscapes](#) page 25). This is because arrays of hachures can:

- Indicate the all-important relative chronology of features
- Distinguish between natural and artificial slopes
- Give a consistent portrayal of earthworks as they turn across or along natural slopes

Hachured survey can be characterised as ‘subjective’, but also as thoughtful and skilful. It requires the measurement and depiction primarily, but not exclusively, of the tops and bottoms of slopes. The depth of interpretation that can be achieved through earthwork survey, especially in combination with other non-intrusive techniques, is considerable.

# 2 Reconnaissance and Control

Before going on to look at the techniques of graphical and plane table survey it is important to emphasise the preparatory work that needs to be done before undertaking any analytical earthwork survey. A large-scale archaeological earthwork survey project begins with a thorough reconnaissance of the site to decide on survey strategy and site logistics. This may involve more than one visit and time spent assessing the site at this stage is amply rewarded as it means there should be no surprises when the survey begins.

Strategic questions addressed at this stage, bearing in mind the purpose of the survey, include:

- deciding on the Level of Survey – see ‘Recording Levels’ in [Understanding the Archaeology of Landscapes](#) for an explanation
- the area to be covered
- the survey techniques, equipment and personnel to be employed
- the scale of the survey and level of accuracy required
- the likely time scale

Logistics questions addressed at this stage include:

- site ownership and access
- health and safety issues
- legal constraints

- level of public access
- presence of grazing animals or other potential issues

The significant point is that thorough and careful reconnaissance saves time later.

With the decision made to deploy manual survey techniques for all or part of the survey, the first stage is the establishment of a network of control points. This is a rigid and accurate framework of fixed points from which the details of the earthworks will be measured. If a TST or GNSS receiver is available then control is best established electronically because electronic survey is accurate, whatever distances are involved. Electronic control survey will not be described here as the techniques are covered in two companion guidance papers: [Traversing the Past](#) for the TST and [Where on Earth are We](#) for GNSS. If electronic survey equipment is not available then the control survey can be done by the manual methods described below. However, errors increase with distance when using tapes or a plane table so great care is required; ideally a manual control network should not be attempted on large sites extending over hundreds of metres.



# 3 Graphical Survey in the Field

Graphical survey, or tape-and-offset survey (sometimes still referred to as ‘chaining’), is a simple method of supplying earthwork measurements and requires only the most basic equipment.

## 3.1 Equipment

The first requirement is for a supply of **pegs or golf tees** to mark points which will form the control network. A can of coloured **biodegradable spray paint** and an engineer’s hard **chalk** stick should also be carried for marking points. For taking measurements, a minimum of three plastic-coated fibron **tape measures**, in a combination of 20m or 30m and 50m lengths, will be suitable for most jobs. A **spike** attached to the zero end of each tape is recommended in order to firmly anchor the end of the tape in order to keep them straight in windy conditions. Failing that, survey arrows can be used to fix the end of the tape. At least two **ranging rods** will be needed for marking base lines. If large numbers are needed, however, bamboo canes with fluorescent tape attached make adequate markers. A **plumb bob** might be necessary for taping on sloping ground. It is extremely useful to have an **optical square** for laying out offsets longer than about 5m, where laying out ‘by eye’ is insufficiently accurate. An optical square consists of two pentagonal prisms mounted one above the other in a plastic or metal housing, enabling the accurate observation of 90° offsets and 180° alignments. It is the only ‘instrument’ generally used in tape-and-offset survey, though a **prismatic compass** (see below) can also be used. An alternative to the optical square is a **crosshead**, a tube mounted on a

ranging rod, with vertical viewing slits at 90° (or 45°) angles to one another.

A good size **drawing board** measuring no smaller than about 0.5m square and light enough to be carried on a shoulder strap is invaluable. Purpose-made boards can be obtained for mounting on a lightweight tripod, providing a portable table that can be very useful. Alternatively, boards can be made cheaply from marine 3-ply covered with a vinyl covering such as Papyroboard.

All field and archive drawings should be on **polyester drawing film** (at least 125microns thick if possible). This medium does not shrink, stretch or warp like paper, and therefore maintains the accuracy of the drawing. To plot the expensively achieved accuracy of a control plot on an unstable medium such as paper is a false economy. Care should also be taken to make sure that the plot of control points is not accidentally degraded or erased in the field when drawing the earthwork detail on top. A way of preventing this is to redraw the control network in reverse on the opposite side of the film to the drawing surface or to use waterproof ink when plotting out a control network surveyed electronically.

The drawing film should be attached to the drawing board with **masking tape** or insulation tape which is more weather resistant. To secure

the film to the drawing board so that it lies as flat as possible, fix the centres of the long sides first, then the centres of the short sides, and only then the corners. Finish off by running tape all around the edge of the sheet to create a dirt and shower proof seal. A **notebook** is always useful for field noting, though this can also be done on the plan or on a voice recorder. If you do not have a drawing board and are not going to draw in the field, a notebook becomes essential to record all the measurements. In this case a surveyor's chaining book is required.

The final essential is a **drawing kit**. This should contain a pencil, preferably a fixed gauge (0.3–0.5mm) clutch type with a hard lead (3H–7H), some spare leads and an appropriate sharpener (a piece of emery board or similar for getting a really fine pencil point is a good idea). A scale rule appropriate for the survey in hand is essential, ideally 15cm long (the 'Toblerone' type with a choice of multiple scales are best avoided – they often lead to errors in plotting as it is so easy to accidentally select the wrong scale). A set square is necessary for laying off right angles (see below) – a 60°/30° type about 15cm long is ideal, larger ones being awkward to use in the field and difficult to pocket. A pencil rubber will be found necessary for precise erasures. A longer straightedge is useful on some sites for drawing long base lines.

Care of such basic equipment is very straightforward. It should all be kept clean and dry. Wet tapes should be left in a loose coil to dry before rewinding, and should be rewound between two fingers of the hand holding the case, to decrease the likelihood of kinking and to remove any mud or dirt. A wet optical square, like any optical instrument, should be left out at normal room temperature to dry gradually before being returned to its case.

## 3.2 Survey Methodology

Graphical survey is best done by two people as there are two distinct roles – one to take the measurements on the ground and the other to plot the measurements out at a chosen scale onto the field drawing. It is of course possible for one person to do both jobs but this will increase the time it takes to complete the survey. There are safety advantages when two people work together and also it helps with the interpretation to have a second pair of eyes. It is essential to the smooth running of the measuring and recording that the two people communicate clearly and efficiently. Over a period they should develop a system of 'verbal shorthand' and of simple hand signals, speeding up the process of survey.

## 3.3 The control network

The basis of graphical survey is taking offset measurements at intervals from a baseline tape stretched between pairs of points called control points. The network of control points is set out at the start of the survey to cover the full extent of the site and then surveyed electronically or plotted by hand to create a plan of the network at the scale chosen for the survey. This is the first stage of the survey. In the second stage, the survey team works systematically across the site using different pairs of points as baselines for measuring from and transferring the measurements to the field plan until the entire area is mapped. The aim is to reduce the site to small, clearly defined portions within which attention to detail can be focussed. Short plastic pegs and golf tees pushed into the ground can be used as control points, or points marked on the ground using biodegradable spray paint – or builders' chalk on stoney sites. These temporary points can be supplemented by 'hard' detail using points which are easily recognised on the ground and on the plot. These are termed 'fixed' points and include the corners of buildings or walls, fence posts, telegraph poles and the corners of drain covers where these fall within or close by the survey area. Sometimes it is useful to choose an intermediate point on hard detail like

a point along a wall or fence to form one end of a baseline. Such intermediate points should be discretely marked with spray paint or chalk to identify them and avoid any chance of error in choosing a point. Care needs to be taken selecting where to place points and what hard detail to use in the control network as this will dictate how efficiently the rest of the survey runs. This skill comes with practice.

Important things to bear in mind when creating the control network are:

- make sure sufficient control points are established to cover the entire site and take care not to leave any areas outside the network. It is also a mistake to set out too many control points as this will make it harder to relate baselines on the ground correctly to pairs of points on the field plot. Understanding the techniques of graphical survey as set out below will make it clear where best to locate control points in relation to the earthworks to be surveyed.

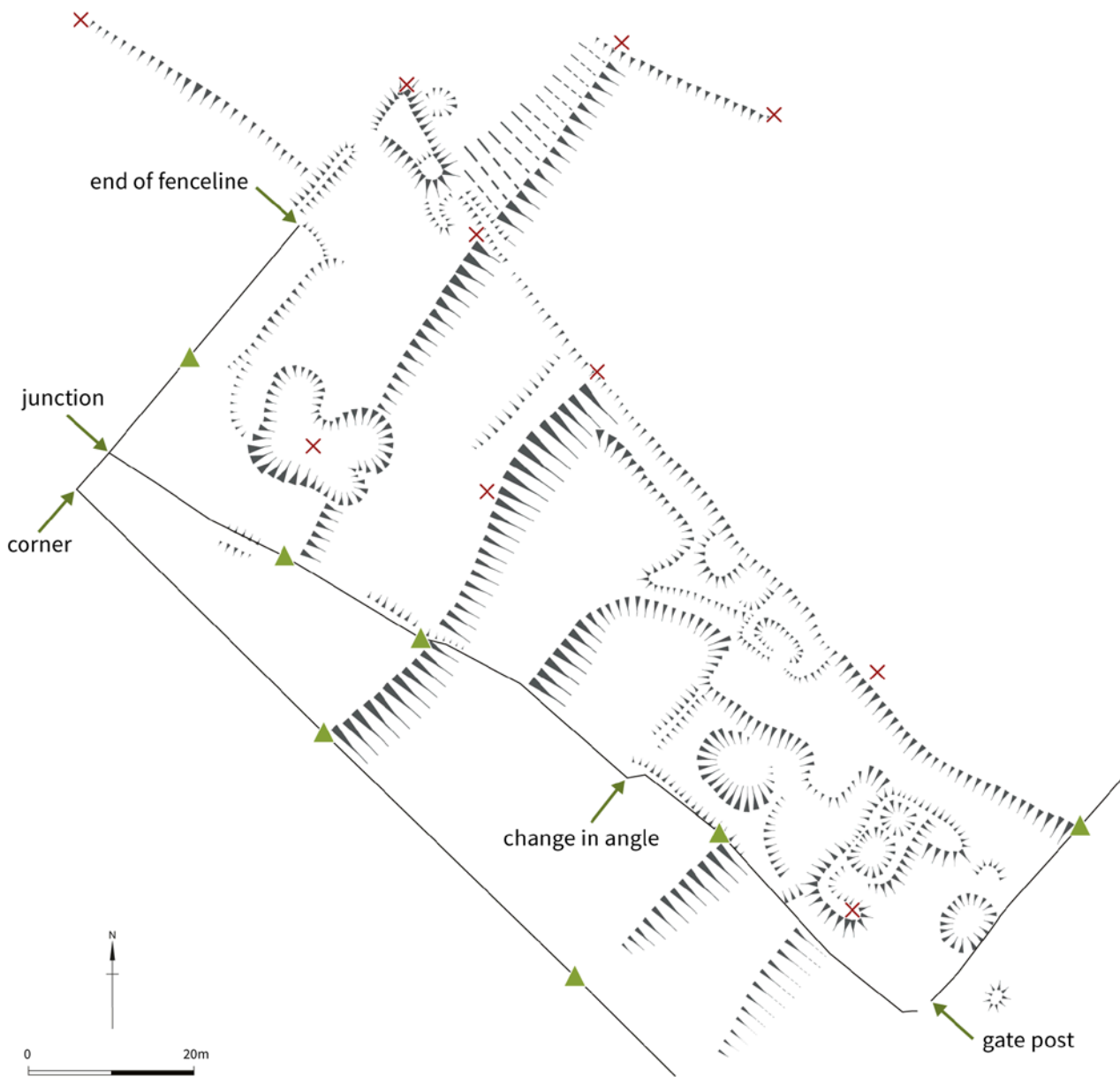

Example control network in relation to earthworks shown as hachures. Red crosses indicate the location of pegs; green triangles the location of intermediate points on hard detail and arrows fixed points on hard detail.

- choose points close to, but not on, archaeological features. In this way long tape offsets on the ground are avoided and the pencil baselines drawn on the field plot will be physically separate from the drawing of the archaeological detail.
- control points should be placed less than 60m apart so that they are within the reach of two 30m tapes laid end to end.

As well as laying out the control network on the ground, it is necessary to survey the points in order to create a plot for use in the field. The most accurate way to plot the control network is using an electronic survey device such as a TST or a GNSS receiver, ideally plotting each point as soon as it is marked on the ground. Alternatively the network can be plotted entirely manually starting with a single base line plotted on the field plan with all the other points then mapped carefully in relation to it using some of the survey techniques described below. Extreme care must be taken to maintain accuracy when establishing a control network in this way as any errors in measuring on the ground or plotting out the control points will mean the detail survey is wrong. A plane table can also be used to record the control network. The use of a plane table is described below. It is advisable when mapping the control network to survey additional detail, such as lengths of roads, field boundaries and sides of buildings as this will help with the orientation of the control plot when using it in the field for the first time.

The resulting plot of the control points then becomes the field plan on which the ‘soft’ archaeological detail is drawn using graphical techniques as described in this section or a plane table as described in the following section. The tops and bottoms of earthworks, intermediate breaks of slope, vegetation changes, parch marks and scatters of stone are typical of the archaeological detail that will be recorded. These sort of features are referred to as ‘soft’ detail because the determination of the exact edge of a feature such as the top and bottom of an earthwork bank is a matter for subjective judgement. Fence lines, telegraph poles, kerb

edges, walls and buildings and other features that appear on published large-scale maps are referred to as ‘hard’ detail and should be included in the survey to help locate the site in the wider landscape.

## 3.4 Detailed Recording

### 3.4.1 The mechanics of tape and offset survey

As has already been mentioned, at its simplest graphical survey involves measuring right-angle offsets from a base line stretched between two control points. Offsets are taken with the aim of recording the maximum detail accurately with the fewest number of measurements. This becomes easier with experience and the person taking the measurements is not only interpreting the archaeology but also trying to make plotting economical for the person drawing on the field plot by choosing the best points at which to take the measurements and making sure they communicate the readings clearly.

The first step is to recognise which end of the baseline tape the zero is at – this seems rather obvious but it is worth checking as it is easy to make a mistake and get the measurements back to front. Secure the ‘0’ end of the tape with a survey arrow at the first peg angled into the ground and run the tape out to the second point taking care to make sure the tape is laid straight on the ground. Secure the box end of the tape at the second point with a second survey arrow and angle it into the ground to keep the tape straight by maintaining tension [see [Clip 1: Pinning a tape at both ends](#)]. Always ‘tie out’ tape lines between control points (that is, measure the full distance) and check by scaling off on the plot before surveying any detail. This should ensure that the pair of control points selected for the baseline are correctly identified on the plot. The offset line is then laid across a feature at right angles to the baseline with the zero end on the baseline tape. It is critical to make sure that the offset is at right angles to the base tape. With experience this can be judged adequately by eye over short distances of up to 5m but over longer distances it is advisable to use an optical square to obtain

the right angle or use basic trigonometry [see [Clip 2: Optical square, raising a right angle from a baseline](#)]. In a triangle with sides 3, 4 and 5 units long (or multiples thereof – a small triangle will not give accurate results if the sides extend

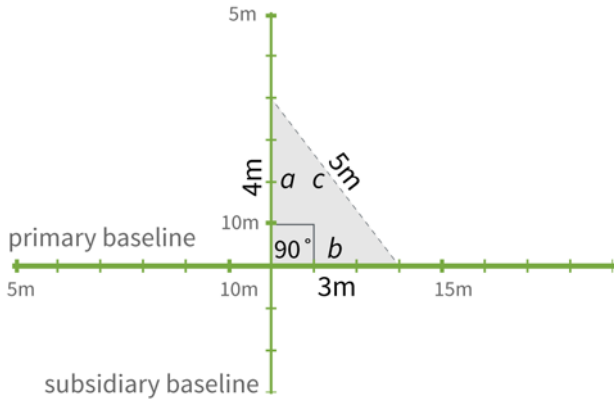

over a long distance), the angle between the two shorter sides is a right angle. This is known as Pythagoras' theorem. A right-angled triangle can be constructed on the base line with two tapes. With the right angle established, at least two measurements are then taken – firstly the distance along the base line from where the offset is being taken and secondly the measurement along the offset line to the feature being recorded. Usually more than one reading is taken along the offset line as for example to locate the top and bottom of a slope and the offset tape can be swung through 180 degrees to record features on the other side of the baseline tape. The pattern of taking measurements is then repeated along the base line tape until all features of interest that can be reached accurately have been measured and plotted. Where features cross the baseline itself these can be measured directly from that tape without the need for any offsets.

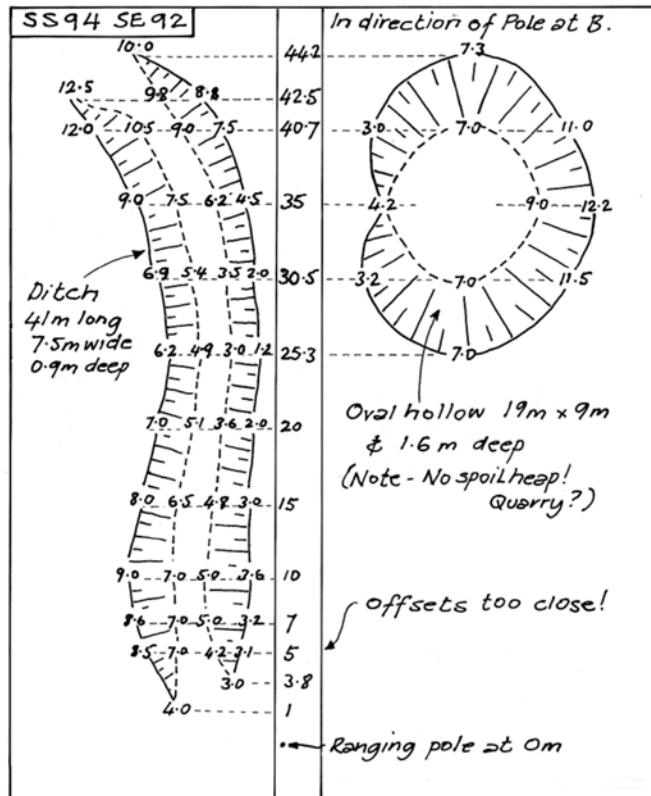

As a variation of the above, it is often necessary to take an offset tape to the base line from a point of interest rather than to raise one from the base line in the hope of hitting the required point. It is imperative in such a situation to make sure that the offset tape stretching back to the baseline meets the base line at right angles. This can be done by 'swinging' the offset tape. The zero end of the offset tape is spiked at the point to be measured and the tape is swung back and forth over the base line [see [Clip 3: Swinging the tape](#)]. The shortest measurement observed on the offset tape as it moves back and forth across the baseline gives the perpendicular. Care has to be taken to avoid snagging the swung tape on tussocks or stones. In this situation a right angle can also be established with an optical square and ranging rods [see [Clip 4: Optical square, finding a right angle on a baseline](#)]. The point to be measured and both ends of the baseline are marked with ranging rods. The surveyor moves along the base line with the optical square, keeping both ranging rods at either end of the base line in view until the image of the third ranging rod at the point coincides precisely.

## Top

Measuring a right angle

## Above

Using tape and offset survey to record earthwork detail in a chaining notebook. The central column represents the tape line A-B, with offsets to detail on either side.

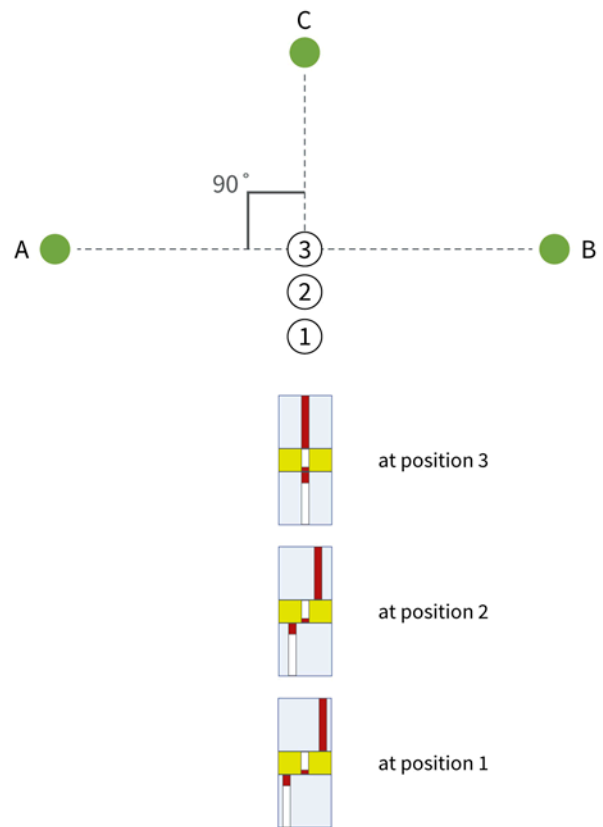
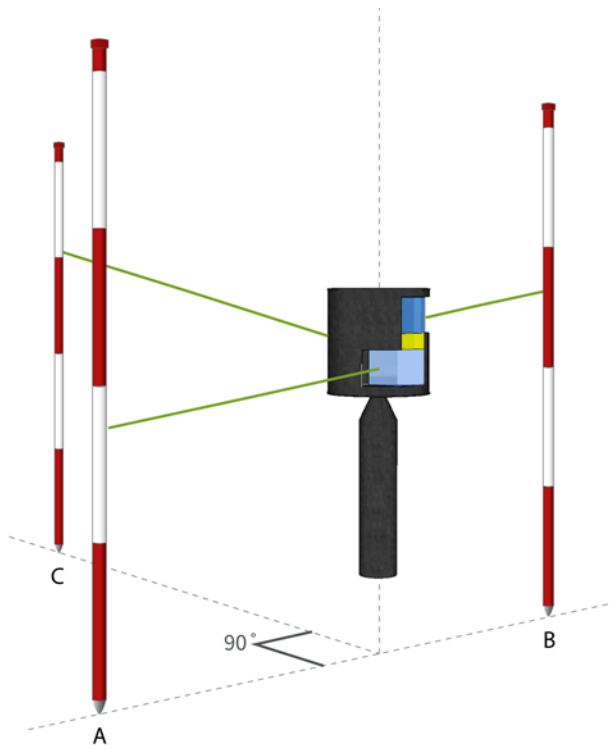

### Using an optical square

The optical prism, held to surveyor's eye at each position, gives different views of the ranging rods at A, B and C. They are in alignment at position 3, on line A-B, with C at an exact right angle.

### 3.4.2 Measuring earthworks

The most efficient way to measure a system of earthworks accurately comes with practice and requires the person undertaking the measuring to be thinking ahead about what needs portraying and how to make best use of each baseline. Avoid simply taking offsets at regular intervals along the baseline and instead look to take measurements at significant points where the earthwork changes shape or meets other features. There are also several general points to bear in mind:

- Remember that 'slope' distance on the ground is longer than the horizontal or 'plan' distance that you wish to plot. When taping on sloping or uneven ground keep the tape measure in the horizontal plane. If necessary, measure a long line down a slope in a series of 'steps', holding the tape level and plumbing down to the ground at convenient points.

- Avoid laying tapes across features at oblique angles, as this can give rise to odd results on plan.
- Lay baselines as close to features as possible, so that you can use short offsets, ensuring accuracy and saving time.
- Remember the implication of the scale you are working at when taking measurements. It is a waste of time to take a measurement to a greater degree of accuracy than can be practically be plotted out at the scale you are working at.

The quality of the survey depends ultimately on the care with which the earthworks and other features are observed, measured and depicted. The actual identification of tops and bottoms of slopes can be difficult and no two people will necessarily agree about exactly where tops,

steep slope bank

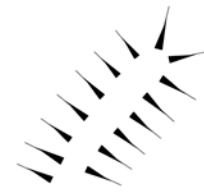
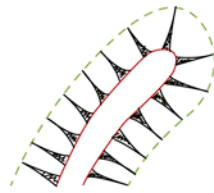

shallow slope bank

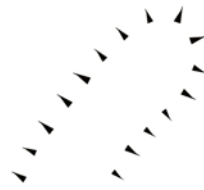
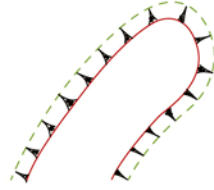

ditch

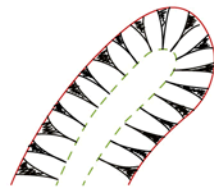

field drawing

finished hachures

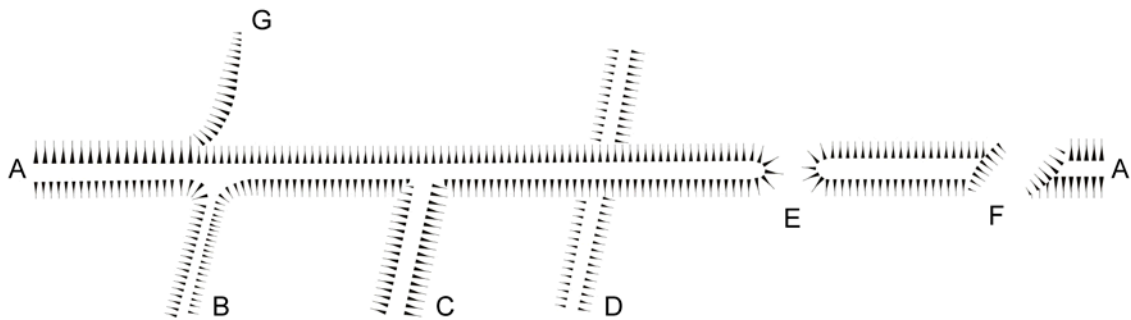
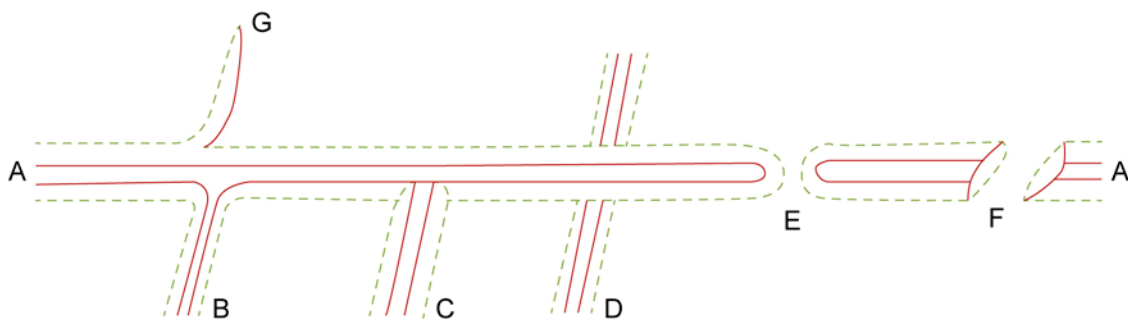

Above

Depicting earthworks in the field and on the final hachure plan.

### The depiction of chronological relationships

Here, bank A-A: has no clear relationship and is probably contemporary with B; is overlain by and therefore earlier than C; overlies and is therefore later than bank D; has a gap, probably original, at E, and has been cut by F. The scarp G fades into the natural topography.

bottoms or end points lie, even where earthworks are clearly defined. In these circumstances taking the measurements in a consistent manner is more important than worrying about the value of each individual measurement. When dealing with very gentle slopes it is best not to over-estimate their width to avoid them appearing too dominant on the final plan.

A linear feature is best surveyed from a base line close alongside or in the case of a bank or ditch it can be easier to align the baseline along the centre of the feature. Circular features are best dealt with by measuring a central point in the feature from an offset and then from that point taking a series of radial measurements around the circumference of the feature. Care must be taken to measure the ends of a slope, or any breaks in its length, accurately. An original terminal in a bank or ditch might appear as rounded in plan – sometimes referred to as a ‘bullnose’, while a later break might give rise to a sharper, more ‘chiselled’ end. Alternatively, a linear slope might fade into the natural topography, in which case measure to a single point where the top and bottom of the feature come together.

The greatest challenge is to recognise chronological relationships between earthworks and so determine which elements are earlier, and which represent later developments, alterations or complete re-workings of the site. Practice and experience bring more confident recognition of such relationships but they must always be sought and, when found, noted and measured accurately. Success in achieving this, and progressing to more detailed interpretation of the ‘total history’ of the site in its landscape setting, is the true end and ultimate justification for earthwork survey. It also confounds the unwarranted accusation that earthwork survey can only deal with the final phase of any site.

### 3.4.3 Drawing up the survey

It is essential that the person doing the drawing observes what is being measured and is on hand to assist with interpretation. It is therefore imperative that the person doing the drawing does not become rooted to one spot but moves with the surveyor.

As each baseline is established on the ground so the person doing the drawing should use a ruler to lightly draw it in on the plot and similarly the offsets derived from it. The same care needs to be taken drawing the offsets on the plot as is taken laying them out on the ground. Some people find it easier than others to draw a right-angle offset on the plot by eye but it is better to use a small set square for this purpose, especially if the offset extends for some distance as even a slight error in plotting out the right angle will lead to a large error in features measured at the furthest end of the offset tape [see [Clip 5: Drawing a right angle](#)]. For example, where it is necessary to use an optical square or geometric method to lay out the offset, it will also be necessary for the plotter to use a set square to plot it. There is no point in taking the trouble to measure the offset accurately on the ground if it is then plotted out ‘by eye’.

It is also important when plotting out to adhere to a set of drawing conventions. A useful convention for use in the field is that tops of slopes are shown by continuous lines and bottoms of slopes by pecked (dashed) lines. So, when the person doing the drawing has plotted out a number of points measured along the top or bottom of a slope for example, they must carefully join the points together with a continuous or dashed line respectively. Draw lines confidently with one single movement of the pencil. Avoid the temptation to ‘sketch’ the line by using several repeated strokes of the pencil and do not use a ruler to join the dots up. To make relationships even clearer on the field drawing, it is often advisable to add hachures to each earthwork or group of earthworks as they are plotted. Ruled lines can be used to draw up hard detail such as straight road edges, fence lines and buildings. A variety of dash-and-dot lines can be used to indicate breaks of slope, vegetation marks and so on as long as they follow a predetermined set of conventions. It is important to work as neatly as possible and to avoid mistakes that require rubbing out, as these can smudge the surface of the plot. Use a light pressure when drawing to avoid thick heavy lines. It is easy to get things wrong on a complex earthwork site so check the plot regularly and correct any mistakes.



### 3.4.4 Other baseline options

It might not always be possible to record every feature accurately only by laying out offsets at right angles from a baseline. No matter how carefully the control network is laid out, some features will be difficult to measure because of their oblique alignment relative to the nearest baseline or because of their distance from the nearest control points. In these cases it is necessary to think more flexibly about how to lay the tapes out. Examples of possible solutions include:-

- measuring from a point on the base line in the direction of another marked point in the control network to establish a secondary baseline. The important consideration here is that the tape does not have to reach the second point – it only needs to be aligned accurately upon it. This technique makes use of distant control points and is especially useful to get a new baseline parallel to a linear feature which is running obliquely to the initial baseline.
- pulling back a point is similar to the above in that it enables a new baseline to be laid out obliquely to the initial base line. This involves putting a ranging rod at a preselected point on the initial base line and fixing the tape at this point. Using a second ranging rod on a distant point in the control network, the surveyor moves away from the first ranging rod keeping that in line with the more distant second ranging rod. This creates a secondary baseline which is aligned to two points in the control network though only fixed to one of them.
- extending a baseline so that it stretches beyond the initial pair of control points can be done simply by placing ranging rods on either end of the base line. Keep the two ranging rods in line and place a third ranging rod at a distance so that it aligns with the first two ranging rods. Measure the distance from the end of the initial baseline to this new point and mark it on the plot as an additional control point.

These techniques and other similar ways of constructing new tape lines accurately are important to bear in mind because they make greater use of the entire control network.

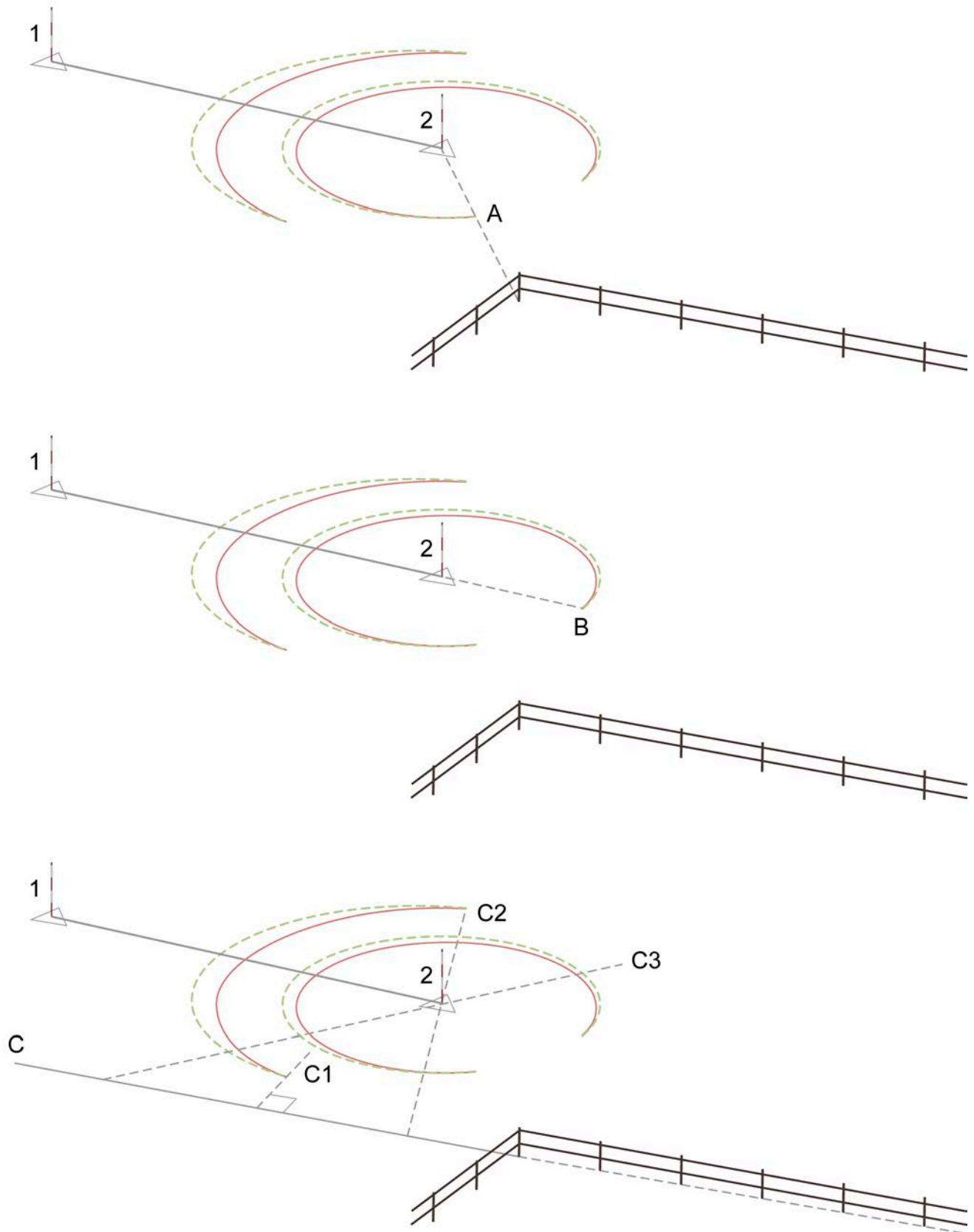

**Ways of establishing new baselines**

Top: A is a measurement 'in the direction of' the fence corner post.

Middle: B is a measurement 'pulling back' from control point 1, through 2.

Bottom: C is a line established by 'extending the straight line' of the fence for offsetting (C1) and 'shots' through control point 2 (C2, C3).

# 4 Plane Table Survey

The plane table is one of the oldest surveying instruments and, though no longer in general use, is still useful for archaeological surveying and is an invaluable tool for teaching the principles of survey. The name refers to the flat drawing board mounted on a tripod with a fitting that enables the board to be rotated and clamped. The board is used in conjunction with a sight rule (more commonly known as an alidade) which comes in varying levels of sophistication. Although the use of plane tables and alidades has been superseded in commercial survey by the use of GNSS and TSTs, it is still possible to buy new equipment and there is a strong secondhand market among survey instrument collectors.

## 4.1 Equipment

The plane table kit consists of a tripod, a drawing board or table that can be mounted on the tripod, and rotated and clamped in the horizontal plane; an alidade (or sight rule), which can be a simple straightedge with sighting vanes or a telescopic type such as a self-reducer (see below); a spirit level (usually a 'pond' bubble) to ensure that the table is level; and a plumbing fork and plum-bob to ensure that the ground position represented on the table is vertically above the actual ground position. Several ranging rods are a useful addition and are essential if using a basic alidade. A telescopic alidade requires the use of a surveying staff for measurement by tacheometry. In addition to these a set of fibron tapes and drawing equipment as used for graphical survey and discussed above will be needed.

### Alidades

- The **basic alidade** is an instrument that measures angles only – a line can be drawn on the plan in precisely the same direction as the object sited on
- A **telescopic alidade** can be used to measure distance by tacheometry, as well as angles
- A **self-reducing alidade** is an optical instrument that automatically converts slope distance to horizontal distance, and enables heights to be calculated. With the self-reducing alidade distances can be read to an accuracy of about 0.1m at 50m (acceptable for large-scale survey). The alidade also comes with a small pricking device to enable measured points to be marked precisely on the field plot by pricking the surface of the film

Some basic alidades and most telescopic ones incorporate parallel motions for increased flexibility of use.



Using a self-reducing alidade

---

## 4.2 Method

There are several ways of using a plane table and alidade; the following describes just one method, called radiation. In this method archaeological detail is surveyed using angular and distance measurements by referencing points in a control network that has been previously surveyed and plotted. A plane table can be used to survey the control network itself at small scales but it is not sufficiently accurate for surveying a control network at a large scale except on small sites (no more than 150m across) where the whole area can be surveyed from one set-up or, at most two set-ups at either end of a measured baseline [see [Clip 6: Simple plane table set-up, sighting alidade, drawing ray](#)]. It is assumed for the purposes of the following description that the network of control points and some of the

hard detail has been surveyed and plotted out as described above for graphical survey. The field plot is then taped to the plane table board and it is especially important to get the plastic film flat on the board and to ensure that the masking tape around the edge is well fixed to allow for smooth movement of the alidade.

Plane tabling with a basic alidade can be done by an individual though, as in graphical survey, there are benefits to working with a partner. If a telescopic alidade is to be used a partner is essential. One person holds a survey staff on the points to be surveyed while the second person observes the staff through the alidade and plots the detail on the table. As with graphical survey, both individuals should discuss and interpret the earthworks.

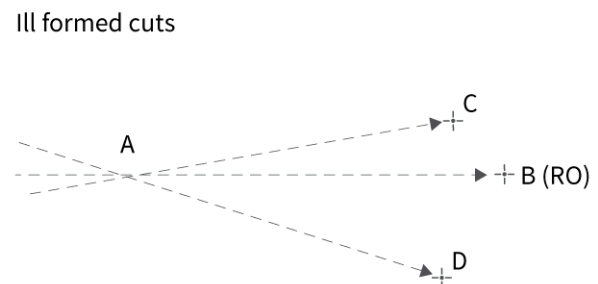
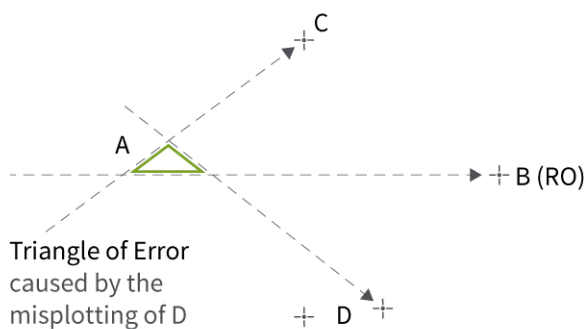
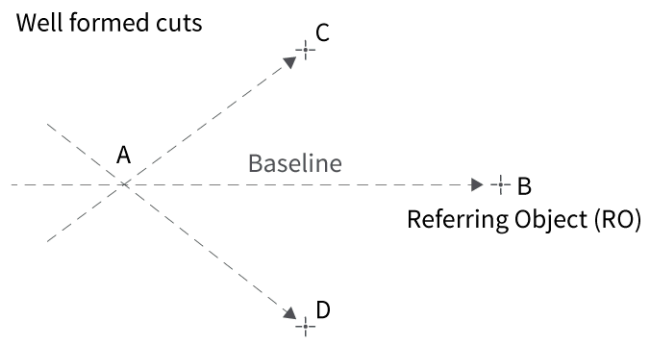
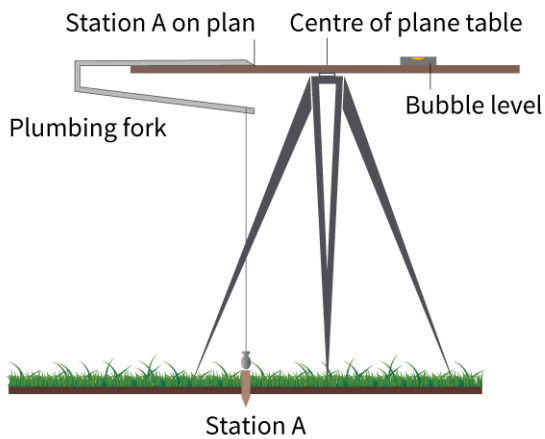

## The plane table set up

Plane tables must be detached from tripods before moving them, to avoid putting undue strain on the joint. An optical alidade should always be transported in its box, and, if it gets damp, must be dried at normal room temperature at the end of the day before being put away. All equipment should be carefully wiped clean before being put away at the end of the day.

### 4.2.1 Setting up and confirming the position of the first station

There are three requirements for a plane table set-up:

- 1 the plane table must be horizontal
- 2 the table must be correctly positioned over the point being used as a station
- 3 the table must be correctly orientated.

The stages in setting up a plane table for radial survey are as follows:

- At the first station the plane table board is mounted on the tripod, approximately orientated to the site, and the whole is set up using the plumbing fork, plum-bob and the pond bubble. Ensure that the tripod is fixed into the ground and the board is level
- Adjust the board on the tripod so that the current control point on the field plot is positioned directly above (within about 10cm of) the point on the ground that it represents [see [Clip 7: Setting up a plane table over an existing survey point](#)].
- Approximately align or orient the board by eye so that the other control points are roughly in their correct relative positions. Gently clamp the board in position.
- In the case of a telescopic alidade, level the instrument using its horizontal and vertical bubbles, and adjust for parallax.

- On the field plot draw a line from the current control point to another visible control point which is termed the Referring Object ('RO'). The RO selected should be beyond the detail which will be recorded from this particular set-up. This maintains accuracy by adhering to the fundamental rule of survey to work within the control, not from the control outwards. The choice of RO will also be limited by the practical consideration that the scaled distance cannot be any further away than the length of the ruler on the alidade blade. Although no distance measurement to the RO is required, the ruler needs to reach between the two points on the plot in order to orientate the board.
- To orientate the board, place the alidade blade along the line previously drawn between the station and the RO on the plot. Sight through the alidade and gently loosen the clamp attaching the board to the tripod. Telescopic alidades have rifle sights to assist with orientation but the final adjustment must be made with the vertical stadia hair of the telescope itself. Ensure that the alidade blade has not moved off the line between the current station and the RO as drawn on the field plot. Clamp the board tightly in position. It is now oriented, the control points on the board and on the ground are in the same relative positions.
- The final stage is to check the orientation by referencing a third control point. It is a fundamental rule of survey to make a check before proceeding because if a mistake has crept in then all subsequent points surveyed from that station will be wrong and a great deal of time will be lost putting the error right. Errors that might occur include:
  - mis-identification of the initial control station and/or the RO on the field plot or on the ground with the result that the plane table is set up over the wrong point.
  - one of the control points has been incorrectly plotted. This is far more likely with a manually surveyed and plotted network than it is with one measured using a TST or GNSS

To check the orientation, first sight onto a third control point with the alidade, keeping the blade on the current station on the field plot (or to the left of this point in the case of alidades with parallel motions). If possible, the third point should be between  $60^\circ$  and  $120^\circ$  to the line between the control station and the RO. Draw a pencil line lightly along the blade through this point; it should cut through the point representing the current station confirming its position. Repeat by selecting a fourth control point preferably on the other side of the line between the current station and the RO and at a similar angle to that used above. When plotted out this additional line should give a perfect trisection on the current station meaning that the three lines of sight (or 'rays') from the RO, and the two control points used for checking meet at a single point which is the current station, proving its absolute accuracy. This procedure confirms another rule of survey: what happens on the ground must also happen on the plan. If, instead of a perfect tri-section at the current station, the three rays form a 'triangle of error', the error must be located before proceeding with survey. Go back to the beginning and check everything – it is usually the only way.

Once the position is checked and confirmed survey can proceed.

Some plane table kits contain a trough compass for supplying accurate magnetic north to the plan. Remove the alidade and any other metal objects from the board. Place the trough compass near the edge of the board and release its clamping screw. Wait for the needle to settle, then slowly turn the compass until it points north. Draw a line

on the plan along the edge of the compass, mark it with an arrowhead and annotate 'magnetic north' and the date. This operation is done at the first set up only, of course.

#### 4.2.2 Preparing to supply survey detail

If the alidade has its own set of scale bars, the correct one should be slid into the parallel bar at this point.

At this stage it is a good idea to have a close look at the archaeological detail, and for the team to discuss what will be shown and how it will be represented on plan. Deal with one small area at a time. Start by surveying any 'hard' detail and other topographic features that have not already been surveyed as part of establishing the control network. These provide a clear framework for the archaeological features, giving shape and form to the survey. This 'hard' detail can also be used to help supply further detail with less effort later on.

There are some rules particular to plane table survey that must be followed to ensure a clear and accurate plan is produced efficiently:

- Do not, under any circumstances, lean on the board; employ a light touch when moving the alidade and drawing. Try to avoid kicking the tripod legs. If you suspect that you have accidentally nudged the set-up, check immediately that the board is still horizontal and correctly orientated
- Draw lightly. Do not obscure the graphics with unnecessarily long or heavy radiation lines
- Wipe the alidade periodically to ensure that there is no grit that might scratch the film; this is particularly important for the relatively heavy telescopic alidades, which tend to be slid across the board rather than lifted
- When using a staff, the surveyor should take care to hold it vertical when a reading is to be taken. If this is not done the observer has to signal the fact to the surveyor. If

the surveyor is not ready for a reading to be taken as, for example, when pausing to examine an area of complex earthworks, holding the staff well off the vertical and with the face averted will indicate to the person doing the plotting that they are not ready for a reading to be taken

- Check the orientation of the board periodically and at the end of each set-up
- The mechanics of plotting the detail on the plane table should not get in the way of joint discussion about the depiction and interpretation of the earthworks

#### 4.2.3 Surveying detail with a basic alidade

Place a ranging rod or other marker on the first point of detail. With the alidade blade on (or to the left of) the current station on the field plot, sight onto the marker and, holding the alidade steady, draw a line along the blade from the current station. This line is described as the ray. On the ground use a tape to measure the distance from the current station to the point of detail and draw the point onto the field plot at the correct scale, marking it with a small dot on the line. If necessary, use a tape to take measurements from the newly plotted point to supply further detail. These can be measurements along the ray towards or away from the current station, or a right-angle offset measurement at a set distance along the ray, or an offset from a point on the ray aligned towards or away from another control point. In this way, for instance, a multi-ditched and banked feature can be plotted by an alidade reading to one point, the remainder obtained by taping across the feature at right angles to it, saving further work with the alidade. Increasing experience tells which 'short cuts' maintain accuracy and which do not. Having captured any detail that can be obtained from the first set-up, move on to the next control point selected for use as a station and repeat the set-up procedures described above. Join points representing tops and bottoms of slopes as described above under graphical survey techniques.

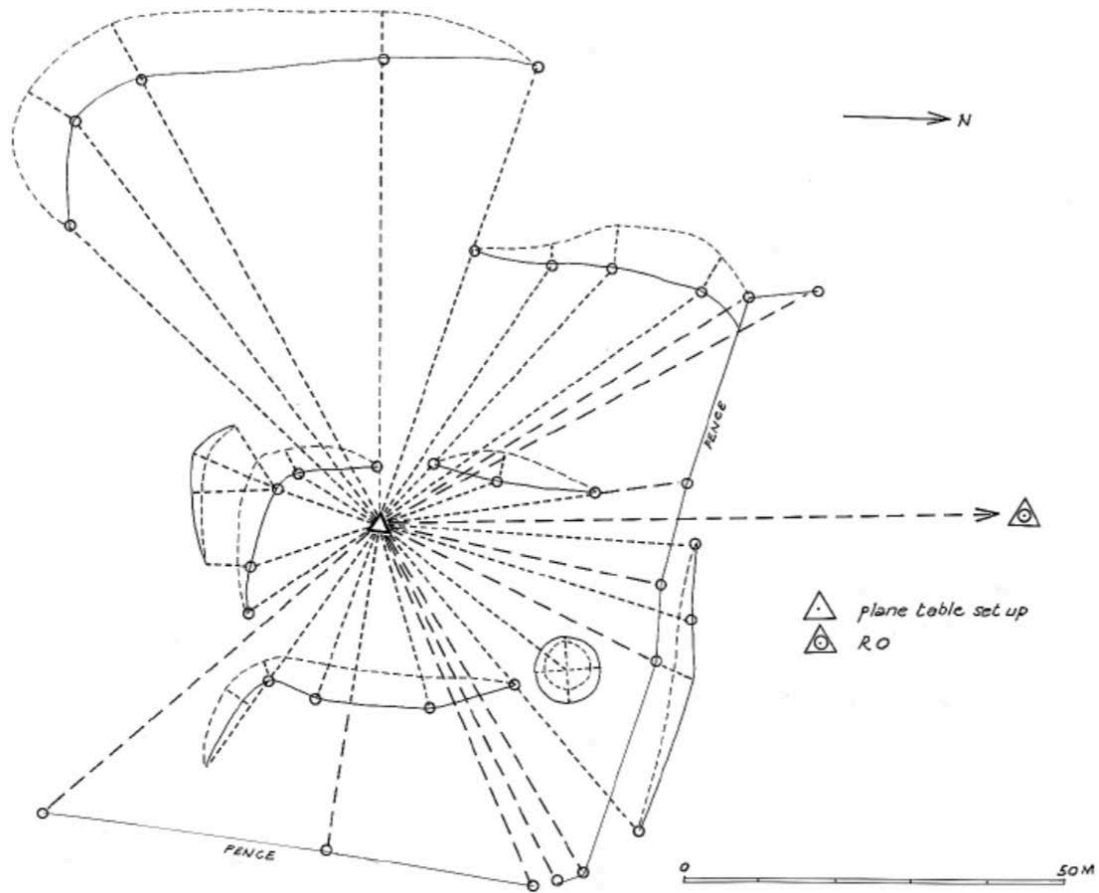

#### Field plot from a single plane table set up

The lines of long pecks represent measurements to 'hard' detail (the fence); the short pecks represent measurements to 'soft' detail. Each primary measurement from the table is represented by a small circle. The subsidiary measurements from these points are all taken along the rays, or 'in the direction of' or 'pulling back' other previously established points. In one case, an offset has been raised from a tape line extending one of the rays.

#### 4.2.4 Surveying detail with a self-reducing alidade

The surveyor holds the staff vertically on the point of detail, facing the plane table and not obscuring the staff with their hands. The observer roughly aligns the alidade on the staff using the rifle sites, ensuring that the blade is to the left of the current station and, sighting through the telescope, uses the horizontal fine adjustment screw to set the vertical stadia hair so that it falls down the centre of the staff. The observer then adjusts the vertical slow motion control to place the lower horizontal stadia hair ('Zero line') to zero on the staff and

reads off the graduations where the upper horizontal stadia hair ('Distance line') cuts the staff, for example if it reads 53.7cm (the .7 must be estimated by eye) then the staff is 53.7m from the alidade where the scale factor is 100.

In practice the bottom of the staff is often obscured, by vegetation for instance, in which case the lower stadia hair can be 'zeroed' on a convenient mark higher up the staff, such as the 1.00m mark, and the distance calculated by reading up from there while treating that mark as a zero line.



Among trees much of the staff might be obscured. In this case read down from the top of the staff or from a convenient decimetre point; as long as the staff is visible where the two stadia hairs fall it does not matter if the rest is invisible. The reading should always be checked carefully under such circumstances.

Having measured the distance, and being careful not to move the body of the alidade, the observer swings the parallel bar across the field plot to the current station and slides the scale bar along until the reading is 53.7 and, holding the bar steady, depresses the pricker. The pricked point represents the relative position of the staff to the current station and hence is the correct position of the detail point on the field plot. After confirming the point has been plotted, the surveyor moves to the next point, or makes subsidiary measurements from this one in the way described above, using the staff or a tape.

#### 4.2.5 Applying checks

In accordance with good survey practice it is essential to keep checking the results. Look at the archaeological detail to ensure that it 'looks right' and is represented correctly and also periodically check the orientation of the board by observing the RO.

#### 4.2.6 Moving on to a second station

When all detail has been obtained from the first station, a final check to the RO ensures that the table has not moved. If it has moved, re-align the table and re-survey the last points taken, correcting the plan. Work back until you find the point where the table moved off orientation, ie where there is no observable error. If you have been applying frequent checks this will not be a long process. The plan should be briefly compared with the ground to make sure nothing has been missed.

Move to the next station, if possible one that has already been confirmed from the first station. As with the first station, take the most distant point available as an RO to obtain the longest orientation. Orient the board on the RO and obtain a tri-section, as was done with the first station. Start plotting detail, tying in one or two points that were supplied from the previous station as a useful check on accuracy.

#### 4.2.7 Intersection

Another method of using the plane table, intersection, can be useful for surveying inaccessible detail, such as the far side of a river bordering a site. The plane table is set up at either end of a measured base line and rays taken to significant points. The intersections of the rays provide the plan position of these points to a reasonable degree of accuracy.

# 5 The Pros and Cons

Having outlined both graphical and plane table survey it should be clear to the reader that both techniques have their own strengths and should be used appropriately, including in combination.

- Tape-and-offset survey copes well with dispersed or linear features; plane tabling is more suitable for compact areas of dense detail because of the time taken to set up on a station. In other words it would not be 'cost effective' to set up a plane table where there were only a few detail points to supply within its range
- A plane table with telescopic alidade is advantageous on broken, undulating ground or in undergrowth where it is difficult to lay out tapes
- Plane tabling with telescopic alidade requires a team of two. Tape-and-offset survey also benefits from teamwork but can be done by one person
- A plane table is always oriented correctly with the ground so the kinds of angular errors that can occur with tape and offset survey are usually avoided
- Plane tables, especially when used with telescopic alidades, tend not perform well in wind and rain though the problems should not be exaggerated. Nevertheless on exposed sites it is wise to supply a closer network of control points so that distances observed are correspondingly shorter

# 6 Ancillary Techniques

## 6.1 Prismatic compass

The prismatic compass offers one of the simplest means of measuring bearings (angles related to magnetic north) accurately. It is hand-held and easily used by one person. As well as its use for orientation, it can be used as a low-order theodolite for measuring relative angles. While still useful for small-scale mapping and sketch surveys the prismatic compass is rarely used in large-scale survey now. Nevertheless, it has been used extensively in the past by Investigators such as RAH Farrer, who described the methodology (1987; see also Brown 1987, 54); some of Farrer's compass surveys have been subsequently checked by TST and found to be accurate.

## 6.2 Pocket level

In earthwork survey it is rarely necessary for tripod-mounted levelling instruments to be used. A pocket level is a hand-held instrument through which heights on a staff can be read to a level of accuracy acceptable for profiling most earthworks. It consists of a tube and a spirit level; the observer sees through the eyepiece a clear view with a horizontal cross hair on one side and the bubble of the spirit level (through a mirror) on the other – when the bubble is opposite the cross hair the instrument is level. The technique requires a team of two.

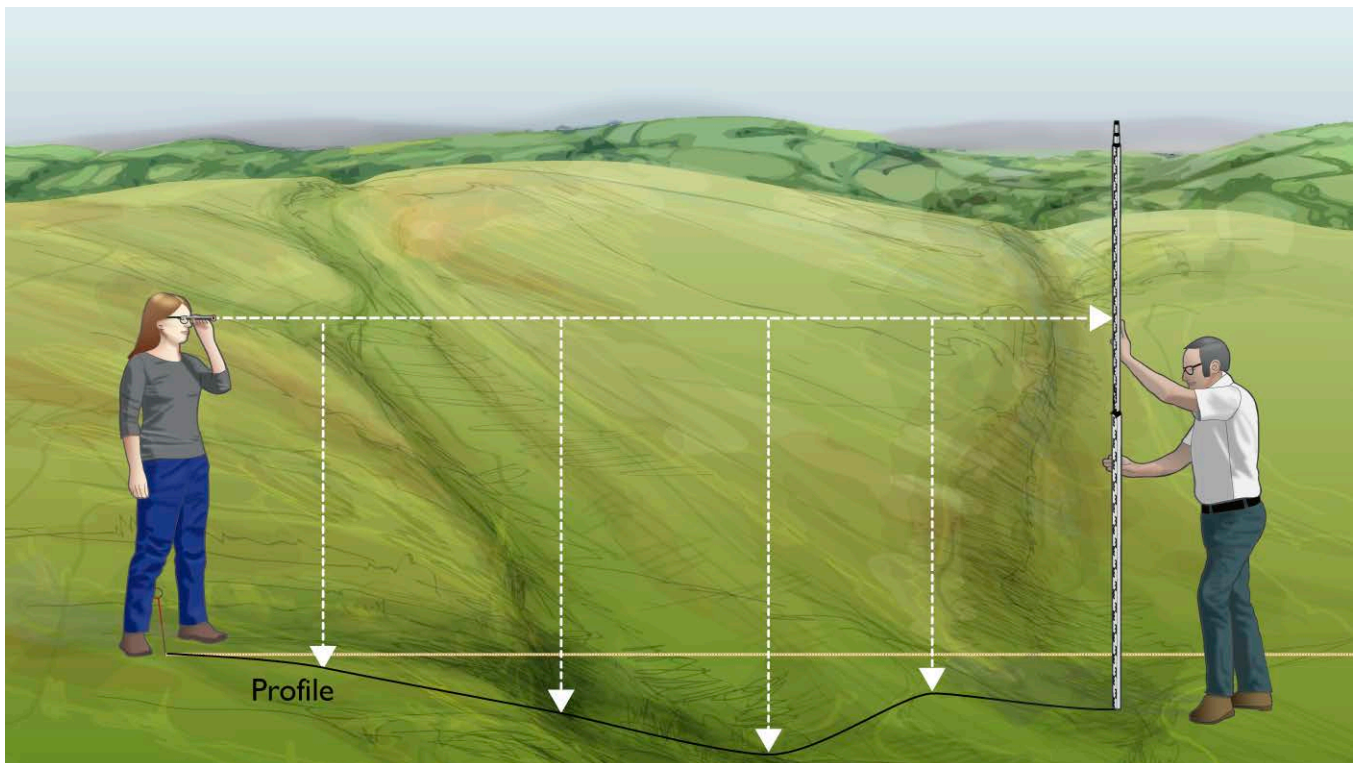

Use of a pocket level to measure slight earthworks.

One acts as the ‘tripod’ and holds the level, adopting a comfortable stance that can be maintained without moving for some time. The other holds the staff or a tape held vertically in the same way as for a levelling exercise with a tripod-mounted instrument. The observer reads the height at the various points to be measured and, preferably, calls them to the staff holder (or a third member of the team) who books them – it is undesirable for the observer to have to move from an observing to a writing position. Because the pocket level is not telescopic it is impossible to read heights over long distances, but this difficulty can be overcome by the staff (or tape) holder moving one finger up and down the staff (or tape) at the instruction of the observer and reading off the height.

Substantial slopes can also be measured with a pocket level if the observer’s eye-height is known [see [Clip 8: Use of pocket level to measure a large earthwork](#)]. Standing at the bottom of the slope, the observer fixes upon a distinctive stone,

plant or tussock observed at eye-height through the level and walks up to it; this is repeated until the top of the slope is reached. Ideally, a colleague with a staff or tape can assist with the final observation. In this case the height of the slope is the observer’s eye-height multiplied by the number of observations taken, minus the reading on the staff at the last observation. In the absence of a colleague this last reading must be estimated. The method cannot be claimed to be very accurate but it is more accurate than guessing.

Fieldworkers rapidly evolve personal rough measuring standards for recording earthwork heights – such as top of the wellington boot 0.4m, knee 0.5m, waist 1.0m, and so on. If a more accurate idea of the height of a small earthwork is necessary, a spirit level taped to a ranging rod makes a handy ‘horizontal’, which can then be laid with one end on the top of the feature and the other end against a tape measure raised vertically from the foot of the feature.

# 7 Products

## 7.1 Field, archive and publication plans

For more detailed information on preparing survey drawings and reports see [Understanding the Archaeology of Landscapes, 2nd edition](#).

The last stage of fieldwork is to check the plot for any errors or omissions and annotate the drawing as necessary. One important task is to define the relative visibility or 'strength' of each slope by indicating on the plot if the slopes are shallow, medium or strong using a three letter coding system. Alternatively, draw hachures on to the slopes to indicate their relative strengths using the stylistic conventions described in detail elsewhere (see [Understanding the Archaeology of Landscapes](#), page 25).

The field drawing should also be marked with the site name and any appropriate reference number(s) such as the local HER reference number and/or that applied to it in the PastScape online database by the Historic England Archive. A dated magnetic north arrow, scale information, date of survey and name(s) of the field team should also appear on the completed field drawing. Avoid the impulse to tidy the drawing up too much for example by erasing construction lines from the tape and offset survey or dirt marks picked up in the field as archaeological detail may be unwittingly removed in the process.

Field notes, which form the basis for the accompanying report, can be written as the survey progresses or compiled as part of the process of checking the field plot. Field notes will include the heights of scarps and depths of depressions (always stating whether they are maximum or average measurements), and their forms, the all-important chronological

relationships, details on the condition of the site and its interpretation, and broader observations about the topographical setting. Notes of plan measurements are usually unnecessary because they can be scaled from the plan, but where they are taken, make it clear in the notes whether they are taken internally or externally, from crest to crest, from lip to lip, etc. Notes can be made on the plan, in a notebook, or on a voice recorder for subsequent transcription, depending upon the preferences of the individual and the requirements of the site. Descriptions, however, should always be as concise, accurate, unambiguous and comprehensive as possible.

The field drawing forms the basis for the archive drawing. The archive drawing is a straight tracing of the field drawing and prior to the advent of computer graphics was prepared using pen and ink on to polyester drawing film. While this is still valid, it is more common to scan the pencil field plot and use this as the basis to prepare a digitised version electronically. However the archive drawing is prepared, it is not necessary to replicate the construction lines and control points shown on the field plot, while hachures are used to depict slopes replacing the top and bottom lines drawn in the field. This can be a problem when working on a digital archive plan as drawing hachures digitally can be more time consuming than drawing them by hand. Hard detail should be shown with line work following whatever conventions have been adopted such as a dashed line for kerbs, thin continuous line for fences, cross-hatching for roofed buildings, etc. Adding text to a digital archive drawing is straightforward while on an inked version this is best tackled using a stencil and should include an information box replicating the information about the survey shown on the original field plot.

A further step is to tie the archive drawing to the Ordnance Survey National Grid, (a task that is called georeferencing) and add grid intersections with their coordinates to the drawing. Done manually this can only be achieved by comparing the hard detail on the survey drawing with the most recent large-scale Ordnance Survey mapping but at best the grid coordinates will only be a rough approximation. If a scanned version of the drawing is subsequently loaded into a GIS system any inaccuracies in the manual georeferencing will become apparent when compared to other digitally georeferenced datasets and the scan will need to be adjusted until it matches correctly. The use of GNSS technology to provide the control network either alone or in conjunction with a TST is the only solution which will fix the survey drawing to the Ordnance Survey grid to a high degree of accuracy. Accuracy of 10cm or better in plan position can easily be achieved nowadays using the latest mapping or survey grade GNSS receivers if the correct transformation routines have been used. If the survey is not georeferenced to the OS National Grid then it is termed a divorced survey, which means that it references a grid specific to that site with a false origin and perhaps not orientated to the north. It is important that this is made clear on the plan by including a north arrow and intersections showing the divorced grid. Whether the plan is a divorced survey or is positioned on to the OS National grid, a clear methodology statement detailing this should be kept with the archive drawing and replicated in the accompanying archive report (see below).

If the survey is to be published consideration must be given to the production of a separate drawing of the survey which meets the criteria set by the publisher – whether the image is submitted digitally or as a physical drawing. Advice on preparing images for publication is available elsewhere while specific instructions should be available from the publisher.

## 7.2 Field notes, archive and publication reports

The plan will mean relatively little on its own. It must be accompanied by a written report which both describes and interprets the evidence recorded by the survey. This archive or 'grey literature' report will be a full descriptive and analytical account of the site. All archaeological features must be described and the evidence interpreted and the archaeological significance discussed. Also include details of the topographical location of the site, and its geology and soils, as well as a brief summary of any previous archaeological investigations. The reasons for the survey and the method(s) by which it was achieved should be recorded along with a listing of sources and bibliographical references. Recommendations for future research or on the management and conservation of the site might also be included but this should be made clear in the initial brief. If the site is then brought forwards to publication, the article should omit much of the descriptive material and concentrate on the discussion and interpretation, highlighting the insights gained through the recording process.

# 8 Conclusion

This document has attempted to show that in the face of rapid advancements in survey technology during the past couple of decades there is still a firm place for 'low-tech' manual techniques in archaeological earthwork survey. Indeed, there is no better way for even the most technically able archaeological surveyor to gain experience of measurement, interpretation and plotting than to begin by using tape measures, a pencil and a drawing board. Time spent measuring by hand and drawing in the field is time well spent as it teaches a pace and rhythm of observation, recording and interpretation that applies equally well when using electronic survey equipment to record earthwork sites. And when the battery fails or the software develops a bug – there is always the tape measure and the drawing board to fall back on.

# 9 Glossary

**Coordinate system.** A pre-defined framework on to which coordinates can be related.

**DTM – Digital Terrain Model.** A digital elevation model of the bare earth topography, without buildings or vegetation

**GIS – Geographical Information System.** A system for capturing, storing, checking, integrating, analysing and displaying data that are spatially referenced to the Earth. This normally comprises a spatially referenced computer database and application software.

**GNSS – Global Navigation Satellite System** (often referred to as GPS). The generic term for satellite navigation systems, including the American Global Positioning System (GPS), Russian GLONASS and other satellite constellations.

**Lidar – Light detection and ranging.** A system that uses laser pulses to measure the distance to an object or surface, typically determining the distance by measuring the time delay between transmission of a pulse and detection of the reflected signal. Lidar is frequently deployed from a plane or helicopter to create 3D models of the ground surface rapidly and accurately to varying degrees of resolution, depending on post spacing.

**TST – Total Station Theodolite.** A tripod-mounted calibrated optical instrument used to measure horizontal and vertical angles and slope distance in order to determine relative position. This involves evaluating the signal returned from the target of a light beam emitted by the unit. On a TST the angles and distance to surveyed points are recorded digitally.



# 10 Where to Get Advice

The archaeological techniques of graphical and plane table survey outlined in this document are specialised and therefore there is no great body of other reference material to consult.

A good general introduction to landscape survey including information on the techniques discussed in this document can be found in Bowden, M (ed) 1999 *Unravelling the Landscape: An Inquisitive Approach to Archaeology*. Stroud: Royal Commission on the Historical Monuments of England (RCHME)/Tempus.

## Video clips referred to in this guidance

Can be viewed on our YouTube channel at:

Clip 1: Laying out a baseline tape  
<https://www.youtube.com/watch?v=27FBBDcCKhI&list=PL6BYFxI5IHBpOozJR4RdR95r7Jgt5QXyX&index=1>

Clip 2: Using an optical square to create a right angle from the baseline  
<https://www.youtube.com/watch?v=n-FT7mln69M&list=PL6BYFxI5IHBpOozJR4RdR95r7Jgt5QXyX&index=2>

Clip 3: Swinging the tape to create a right angle from the baseline  
<https://www.youtube.com/watch?v=h0o4UncRaec&index=3&list=PL6BYFxI5IHBpOozJR4RdR95r7Jgt5QXyX>

Clip 4: Finding a right angle on the baseline using an optical square  
<https://www.youtube.com/watch?v=OEDmsieY9ro&index=4&list=PL6BYFxI5IHBpOozJR4RdR95r7Jgt5QXyX>

Clip 5: Drawing a right angle  
<https://www.youtube.com/watch?v=Lh9ur-8Ulo8&list=PL6BYFxI5IHBpOozJR4RdR95r7Jgt5QXyX&index=5>

Clip 6: Setting up a plane table, sighting the alidade and drawing a ray  
<https://www.youtube.com/watch?v=deVZyY1PE2M&list=PL6BYFxI5IHBpOozJR4RdR95r7Jgt5QXyX&index=6>

Clip 7: Setting up a plane table over an existing survey control peg  
<https://www.youtube.com/watch?v=ks3fD1hkDSs&list=PL6BYFxI5IHBpOozJR4RdR95r7Jgt5QXyX&index=7>

Clip 8: Use of pocket level to measure the height of a large earthwork  
<https://www.youtube.com/watch?v=0qZ-KpbKpxQ&index=9&list=PL6BYFxI5IHBpOozJR4RdR95r7Jgt5QXyX&t=0s>

## Historic England

The Historic England [online database of research reports](#) contains many examples of field surveys conducted by its in-house field teams during the past 10-15 years, including examples of sites recorded wholly or in part using graphical and plane table techniques. Each report will contain a methodology statement explaining how the survey was undertaken. Consulting a selection of the reports will give a good idea of what can be achieved by analytical field survey. For example the survey of the extensive remains of

the deserted medieval village at Wharram Percy [<http://research.historicengland.org.uk/Report.aspx?i=15451&ru=%2fResults.aspx%3fn%3d10%26a%3d4489%26p%3d3>] in North Yorkshire was surveyed in 2002 using control and hard detail supplied by GPS and earthwork detail largely supplied by tape and offset.

It is also worth consulting other guidance by Historic England on complementary survey techniques, some of which have been touched on in this document. These include:

Historic England 2017 *Understanding the Archaeology of Landscapes* Second Edition. Swindon. Historic England.

[HistoricEngland.org.uk/images-books/publications/understanding-archaeology-of-landscapes/](http://HistoricEngland.org.uk/images-books/publications/understanding-archaeology-of-landscapes/)

This guidance provides practical advice on the recording, analysis and understanding of earthworks and other historic landscape features using non-intrusive archaeological field survey and investigation techniques. It describes and illustrates approaches to archaeological field survey, drawing conventions and Levels of Survey for record creators and users drawing on the experience of Historic England field teams.

Historic England 2016 *Traversing the Past: The Total Station Theodolite in Archaeological Landscape Survey*. Swindon. Historic England.

[HistoricEngland.org.uk/images-books/publications/traversingthepast/](http://HistoricEngland.org.uk/images-books/publications/traversingthepast/)

This guidance explains how to set out survey control and gather archaeological detail using an electronic theodolite and how to follow best practice to maintain accuracy. Examples are given of surveys where a theodolite has been used in conjunction with tape and offset survey.

Historic England 2016 *Where on Earth Are We? The Role of Global Navigation Satellite Systems (GNSS) in Archaeological Field Survey*. Swindon. Historic England.

[HistoricEngland.org.uk/images-books/publications/where-on-earth-gnss-archaeological-field-survey/](http://HistoricEngland.org.uk/images-books/publications/where-on-earth-gnss-archaeological-field-survey/)

This guidance covers the range of different GNSS

devices in use in archaeological survey and explains the different levels of accuracy that they are capable of. It shows how to use GNSS to locate a site accurately onto the British National Grid.

Historic England 2017 *Photogrammetric Applications for Cultural Heritage. Guidance for Good Practice*. Swindon. Historic England.

[HistoricEngland.org.uk/images-books/publications/photogrammetric-applications-for-cultural-heritage/](http://HistoricEngland.org.uk/images-books/publications/photogrammetric-applications-for-cultural-heritage/)

This guidance covers the practical application of photogrammetry in recording cultural heritage. Included in the description of the various photogrammetric techniques is guidance on using airborne imagery from small unmanned aircraft to create digital 3D models of earthwork sites.

Historic England 2018 *Using Airborne Lidar in Archaeological Survey: The Light Fantastic*: Swindon. Historic England.

[HistoricEngland.org.uk/images-books/publications/using-airborne-lidar-in-archaeological-survey/](http://HistoricEngland.org.uk/images-books/publications/using-airborne-lidar-in-archaeological-survey/)

This guidance shows how lidar data can be used for locating archaeological sites. It explains how lidar data is created and through a series of case studies shows how it has been used by Historic England survey teams.

### **Historic Environment Scotland and partners – Scotland's Rural Past Project**

A suite of four training films were created as an introduction to survey techniques for the Scotland's Rural Past project, which ran between 2006 and 2011. They include 'using a Plane Table' and 'using Tape and Offset'.

[https://www.scotlandsruralpast.org.uk/index.php?option=com\\_content&view=article&id=325&Itemid=345](https://www.scotlandsruralpast.org.uk/index.php?option=com_content&view=article&id=325&Itemid=345)

A publication was also issued in 2011 support of the project called *A Practical Guide to Recording Archaeological Sites*

<http://www.scotlandsruralpast.org.uk/images/pdfs/SRP%20Manual%20single%20page.pdf>

which includes sections on measuring and mapping sites and creating scaled drawings.

## The Landscape Survey Group

Finally the Landscape Survey Group (LSG) [<http://landscapesurvey.org>] provides a forum for those carrying out or using archaeological landscape surveys, and aims to maintain a body of experienced and committed practitioners. Through social media and an annual conference it facilitates the exchange of ideas and information relating to archaeological landscape survey.

## Contact Historic England

East of England  
Brooklands  
24 Brooklands Avenue  
Cambridge CB2 8BU  
Tel: 01223 582749  
Email: [eastofengland@HistoricEngland.org.uk](mailto:eastofengland@HistoricEngland.org.uk)

Fort Cumberland  
Fort Cumberland Road  
Eastney  
Portsmouth PO4 9LD  
Tel: 023 9285 6704  
Email: [fort.cumberland@HistoricEngland.org.uk](mailto:fort.cumberland@HistoricEngland.org.uk)

London  
Fourth Floor  
Cannon Bridge House  
25 Dowgate Hill  
London EC4R 2YA  
Tel: 020 7973 3700  
Email: [london@HistoricEngland.org.uk](mailto:london@HistoricEngland.org.uk)

North East  
Bessie Surtees House  
41-44 Sandhill  
Newcastle Upon Tyne NE1 3JF  
Tel: 0191 269 1255  
Email: [northeast@HistoricEngland.org.uk](mailto:northeast@HistoricEngland.org.uk)

North West  
3rd Floor, Canada House  
3 Chepstow Street  
Manchester M1 5FW  
Tel: 0161 242 1416  
Email: [northwest@HistoricEngland.org.uk](mailto:northwest@HistoricEngland.org.uk)

South West  
29 Queen Square  
Bristol BS1 4ND  
Tel: 0117 975 1308  
Email: [southwest@HistoricEngland.org.uk](mailto:southwest@HistoricEngland.org.uk)

Swindon  
The Engine House  
Fire Fly Avenue  
Swindon SN2 2EH  
Tel: 01793 445050  
Email: [swindon@HistoricEngland.org.uk](mailto:swindon@HistoricEngland.org.uk)

West Midlands  
The Axis  
10 Holliday Street  
Birmingham B1 1TG  
Tel: 0121 625 6870  
Email: [westmidlands@HistoricEngland.org.uk](mailto:westmidlands@HistoricEngland.org.uk)

Yorkshire  
37 Tanner Row  
York YO1 6WP  
Tel: 01904 601948  
Email: [yorkshire@HistoricEngland.org.uk](mailto:yorkshire@HistoricEngland.org.uk)



# Historic England

We are the public body that helps people care for, enjoy and celebrate England's spectacular historic environment, from barrows and baileys to parks and practice trenches.

Please contact [guidance@HistoricEngland.org.uk](mailto:guidance@HistoricEngland.org.uk) with any questions about this document.

[HistoricEngland.org.uk](http://HistoricEngland.org.uk)

If you would like this document in a different format, please contact our customer services department on:

Tel: 0370 333 0607

Email: [customers@HistoricEngland.org.uk](mailto:customers@HistoricEngland.org.uk)

All information and weblinks accurate at the time of publication.

Please consider the environment before printing this document

HEAG256

Publication date: v1.0 March 2002 © English Heritage

Second edition: October 2018 © Historic England

Design: Historic England